



YLI ELECTRONIC  
意林電子



# 智能堅固型低溫電插鎖附鎖膽

Model: YB-620(LED)

## 技術參數

鎖體尺寸	150Lx36Wx57H(mm)
門門板尺寸	150Lx36Wx3H(mm)
鎖芯尺寸	16.5mm(凸出長度)x20mm(直徑)304不銹鋼高強度實心鎖舌
信號輸出	門狀態信號輸出NO/COM接點 鎖狀態信號輸出NO/NC/COM接點
延時功能	0/3/6/9秒可調
工作電壓	12VDC
工作電流	啓動電流：1000mA,工作電流：350mA
安全類型	斷電上鎖
LED顯示	上鎖燈亮；開鎖燈滅
門縫磁感距離	3-8mm以內
適用範圍	木門/玻璃門/金屬門/防火門
面板材料	304不銹鋼面板，表面拉絲處理
產品重量	1.25kg

## 尺寸圖

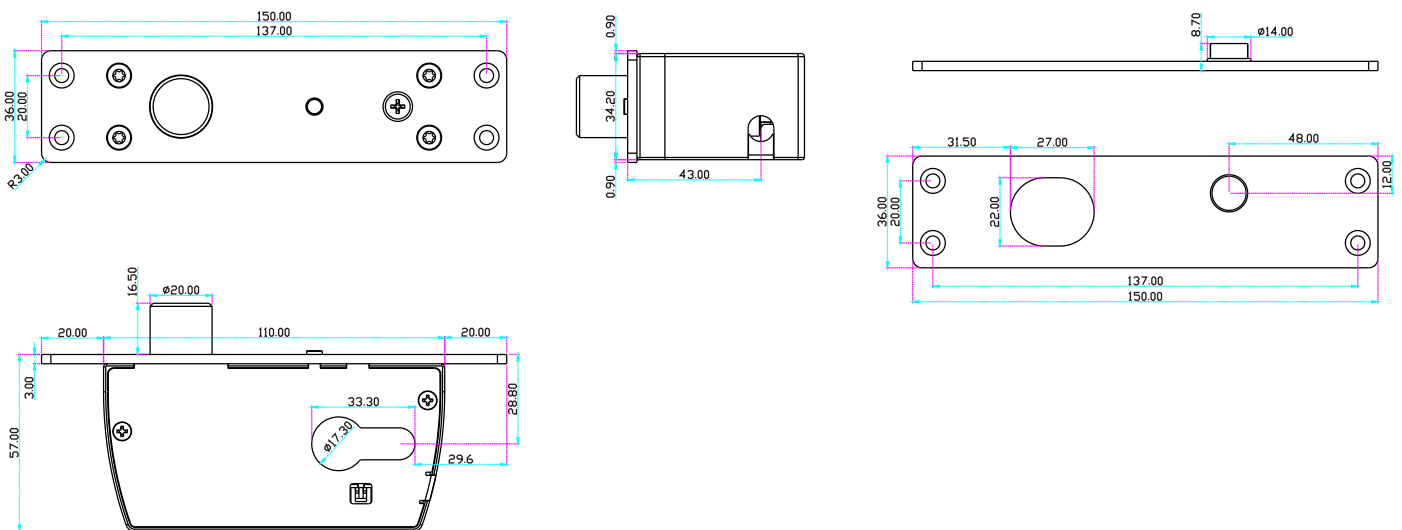

## 鎖芯選擇

可選配單開鎖芯或雙開鎖芯，可訂其他尺寸：  
如80/90/100/110/120mm。

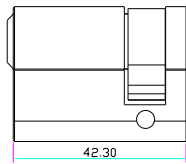
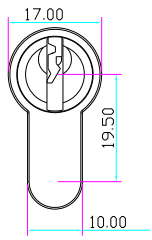

單開鑰匙半鎖膽

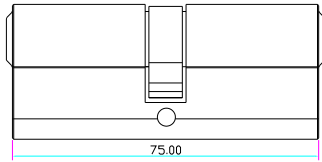
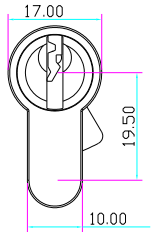

雙開鑰匙雙鎖膽

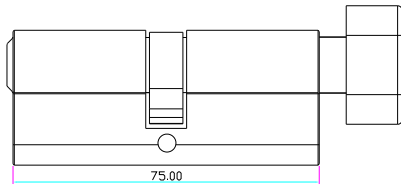
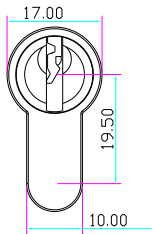

單開鑰匙帶旋鈕開門(標準出廠配套)

## 接綫

	紅色		+ 12V DC	
	黑色		-	
	橙色		OPEN	
	藍色		NO	} 鎖狀態信號輸出
	棕色		NC	
	灰色		COM	
	綠色		NO	} 門狀態信號輸出
	白色		COM	

## 延時設置

自動上鎖延時時間設定



0.0 SEC



6.0 SEC



3.0 SEC



9.0 SEC

## 安裝示意圖

