



YLI ELECTRONIC

ANSI standard Heavy Duty Electric Strike



Patent: No.201320470904.1

Specification

| Model | Face Plate | Voltage | Current | Feature | Suitable for | Signal output | Weight |
|----------------|------------------------------------|----------------------------------|-------------------------|----------------------------------|---|---------------|--------|
| YS-138 | 124Lx43Wx35H | DC 12V(Default) DC 24V(Order) | 12V/320mA; 24V/160mA | Fail secure(NO) Fail safe(NC) | Wooden door Metal door Glass door | No | 0.38kg |
| YS-138-S | 124Lx43Wx35H | DC 12V(Default) DC 24V(Order) | 12V/320mA; 24V/160mA | Fail secure(NO) Fail safe(NC) | Wooden door Metal door Glass door | Yes | 0.38kg |
| YS-138L | 165Lx43.7Wx35H | DC 12V(Default) DC 24V(Order) | 12V/320mA; 24V/160mA | Fail secure(NO) Fail safe(NC) | Wooden door Metal door Glass door | No | 0.40kg |
| YS-138L-S | 165Lx43.7Wx35H | DC 12V(Default) DC 24V(Order) | 12V/320mA; 24V/160mA | Fail secure(NO) Fail safe(NC) | Wooden door Metal door Glass door | Yes | 0.40kg |
| YS-138LK | 250Lx43.7Wx35H | DC 12V(Default) DC 24V(Order) | 12V/320mA; 24V/160mA | Fail secure(NO) Fail safe(NC) | Wooden door Metal door Glass door | No | 0.42kg |
| YS-138LK-S | 250Lx43.7Wx35H | DC 12V(Default) DC 24V(Order) | 12V/320mA; 24V/160mA | Fail secure(NO) Fail safe(NC) | Wooden door Metal door Glass door | Yes | 0.42kg |
| Durable design | Mechanical test: 1, 000, 000 times | | | | | | |

Diagram(unit:mm)

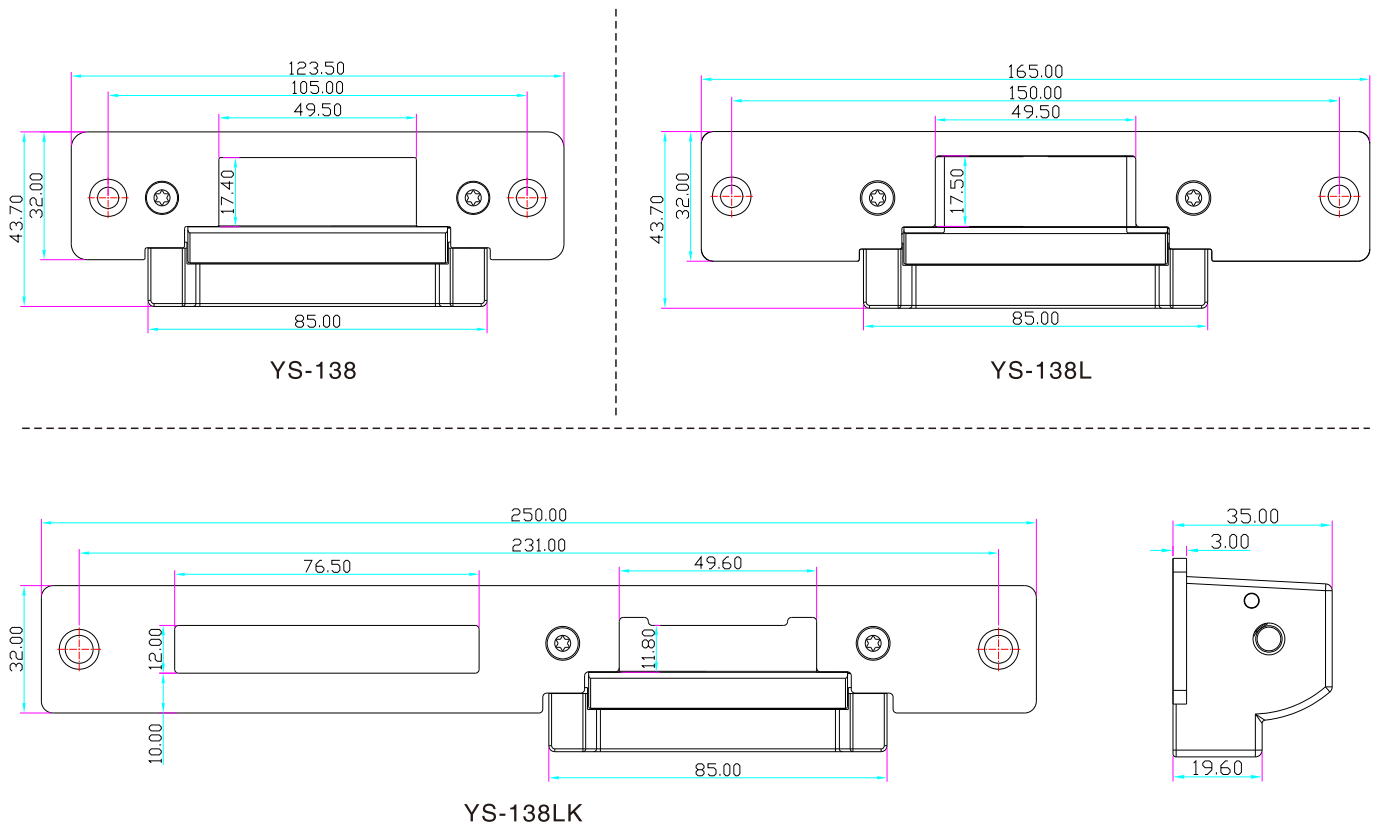

Signal Output

Green: NO
 White: COM
 Yellow: NC
 Red: +
 Black: -

Door Status

N.C. contact output : open status
 N.O. contact output : closed status
 DC 12V(Default); DC 24V(Order)

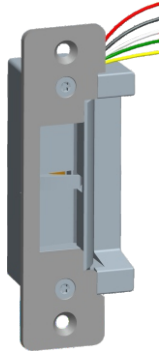

Accessories

If the door frame is too thick, please use the extension plate. Installation is as the follows.

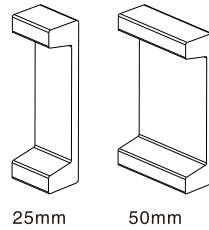

Extension plate(need order)

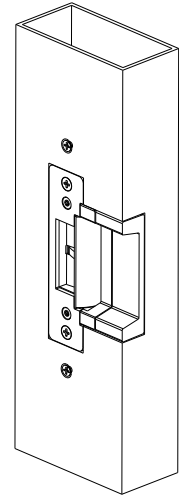

Function Conversion

You can set the operation mode of Fail Safe or Fail Secure.

Loose the screw and tighten it in the other hole.
 Fail Safe(NC): When power off, the door is in the open status.

Fail Secure(NO): When power off, the door is in the closed status.

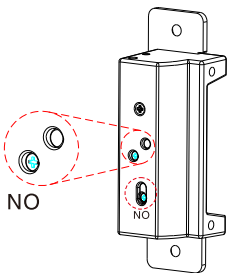

Fail Secure

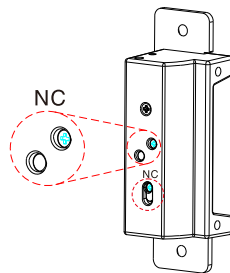

Fail Safe

Options of Mechanical Lock

Suitable for: YS-138, YS-138L

Suitable for: YS-138LK

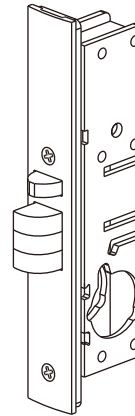

YS-305/306

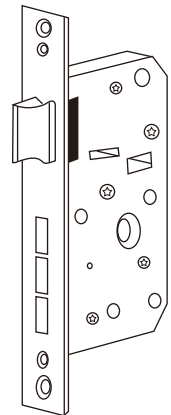

YS-308

Installation Diagram

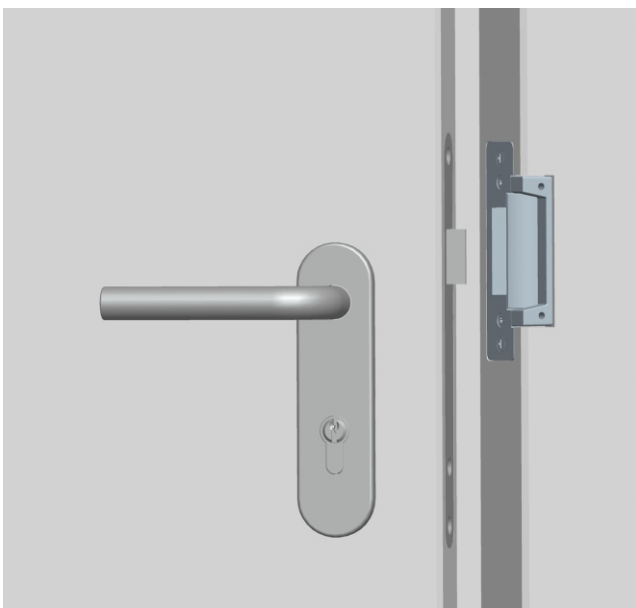

Overall Dimensions

